



ICS

Strong and reliable

ICS. Strong and reliable

Thanks to ICS you boost the convenience of your system, can rely on planing and investment security as well as the durability and long service life of the system. ICS is a durable reversible key system with high expansion cababilities, so that future master key system extensions can be planned ahead. Be it office buildings, schools or student residences, ICS will convince you.



ICS benefits at a glance

- › Increased copying protection
 - › For complex master key system structures
 - › High levels of protection against burglary
 - › Patent protection until 2029
-

The access system for complex master key system structures

ICS is ideal for master key system with a complex structure and a large number of different user groups. For example in office buildings, hotels, associations, student apartments and nursing homes. In cooperation with qualified partners, EVVA has been providing security technology for a hundred years.



Primetower | CH



BG/BRG Pichelmayergasse | AT

ICS. One system, many details

ICS offers different locking technologies for high protection: The durable length profile and the distinctive track system with internal recesses. The scanning takes place in five tracks through 13 spring-loaded locking elements and the durable length profile. As a reversible key system, ICS ensures comfort: The key's thickness of 3 mm and the high-quality nickel silver alloy make it convenient, durable and resistant to wear.

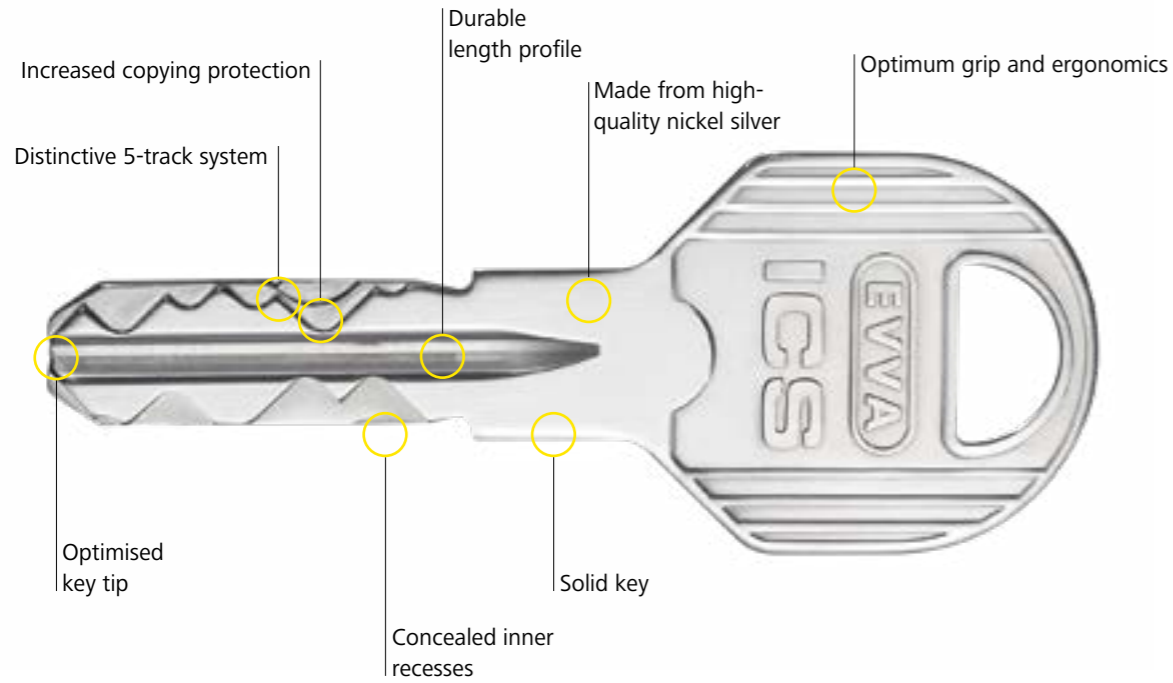

Practical, handy and appealing.

Optionally, ICS keys are available in a range of colours. The colour coding helps to easily distinguish between keys.

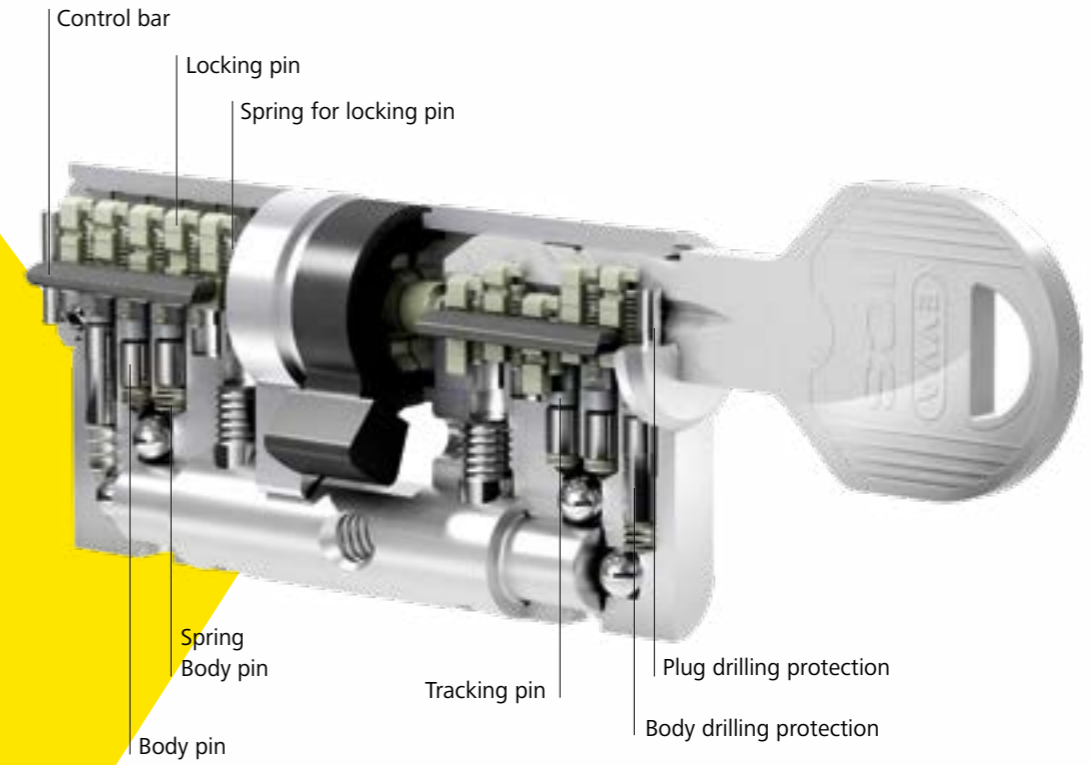

All-round protection:

Copy keys, additional cylinder and lock charts are available from authorised EVVA Partners but only with corresponding proof of legitimacy, the EVVA security card.

Benefit from the security features

The reliable ICS cylinder technology offers lasting protection against illegal opening methods:

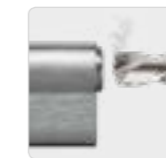

Drilling protection



Plug pulling protection



ICS. Plan view

Due to their features and numerous variants and options, ICS cylinder locks can handle all access situations that a master key system may meet.

Thus, access to rooms and storeys, access to cabinets and showcases or the activation of barriers or other electronic equipment can be clearly structured. This means even more comfort and more security.



Furniture cylinder
ensure secure storage of important documents.



Thumb turn cylinder
allows convenient opening and closing without keys.



Switch cylinder with integrated micro-switch
control electronic systems, such as automatic sliding doors.



Double cylinder
are suitable for indoor and outdoor use and can be configured with a number of variants and options.



Switch cylinder
actuate control elements such as those in lift systems.



Cam locks
for letter boxes systems and for secure storage in showcases and cabinets.



Half cylinder
are suitable for barriers, key switches, lifts and numerous other situations.

The right cylinder for every situation

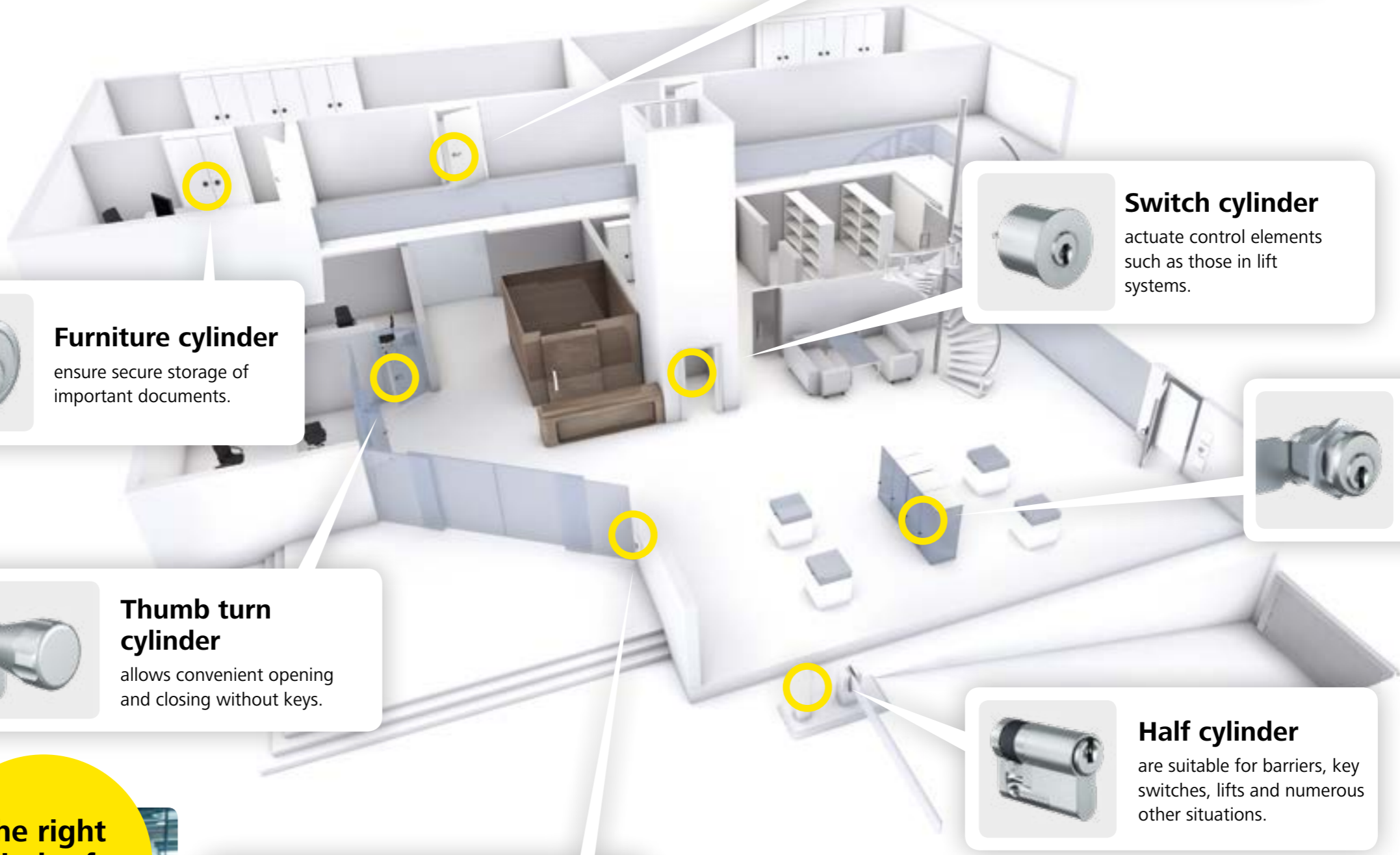

ICS. Master key systems and structure

EVVA and its project partners have been creating and developing lock charts since almost 100 years, using their extensive know-how to achieve great success.

ICS with its coding characteristics, length profile, curve scanning and internal scanning elements is particularly suitable for very large objects that must take special authorisations into account in the locking hierarchy.

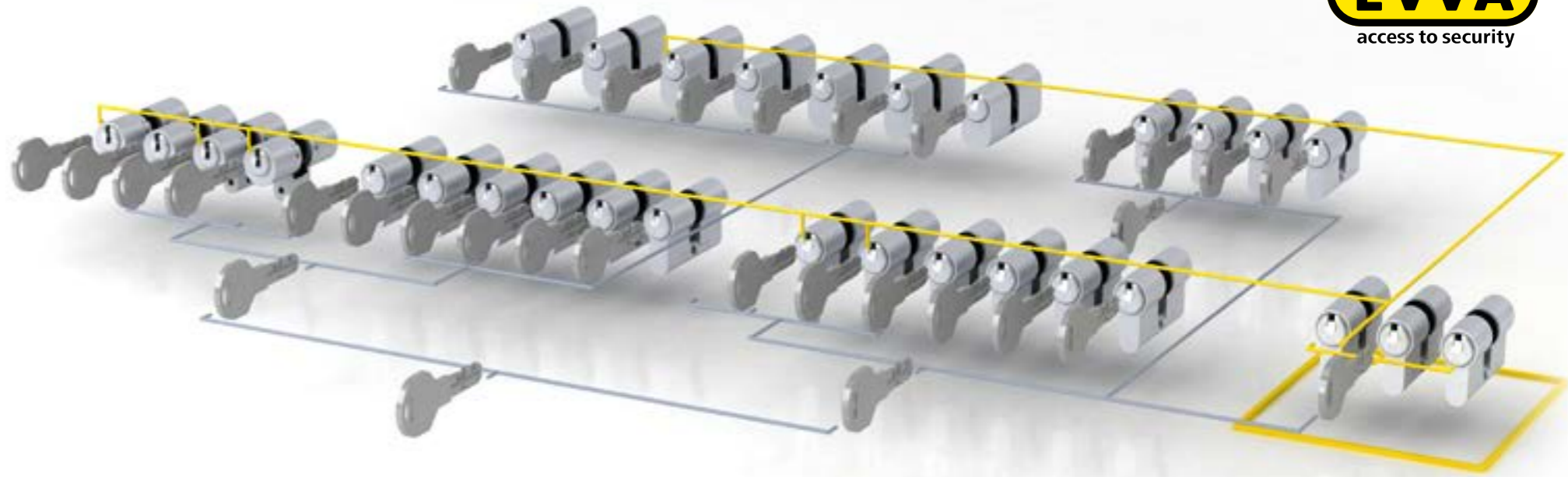

Example of an residential complex

For apartment cylinders, future master key system extensions are taken into account. If an individual key (ES) is lost, it can be replaced by a new individual key, which again locks all the central cylinders and sub central cylinders.

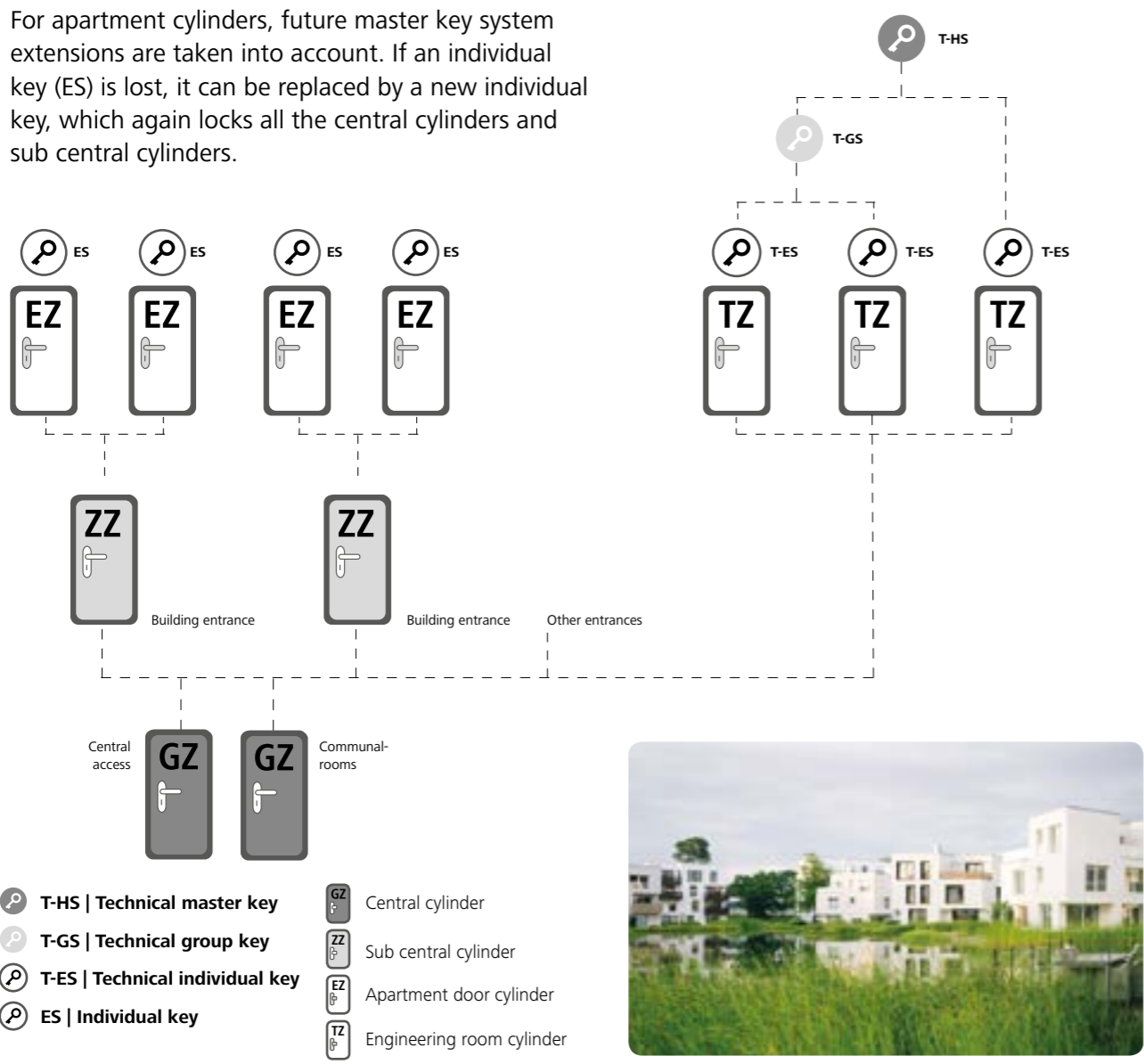

Example business building

Grand master key system with complex structure. ICS master key system extensions are easy to implement thanks to its extensive expansion capabilities.

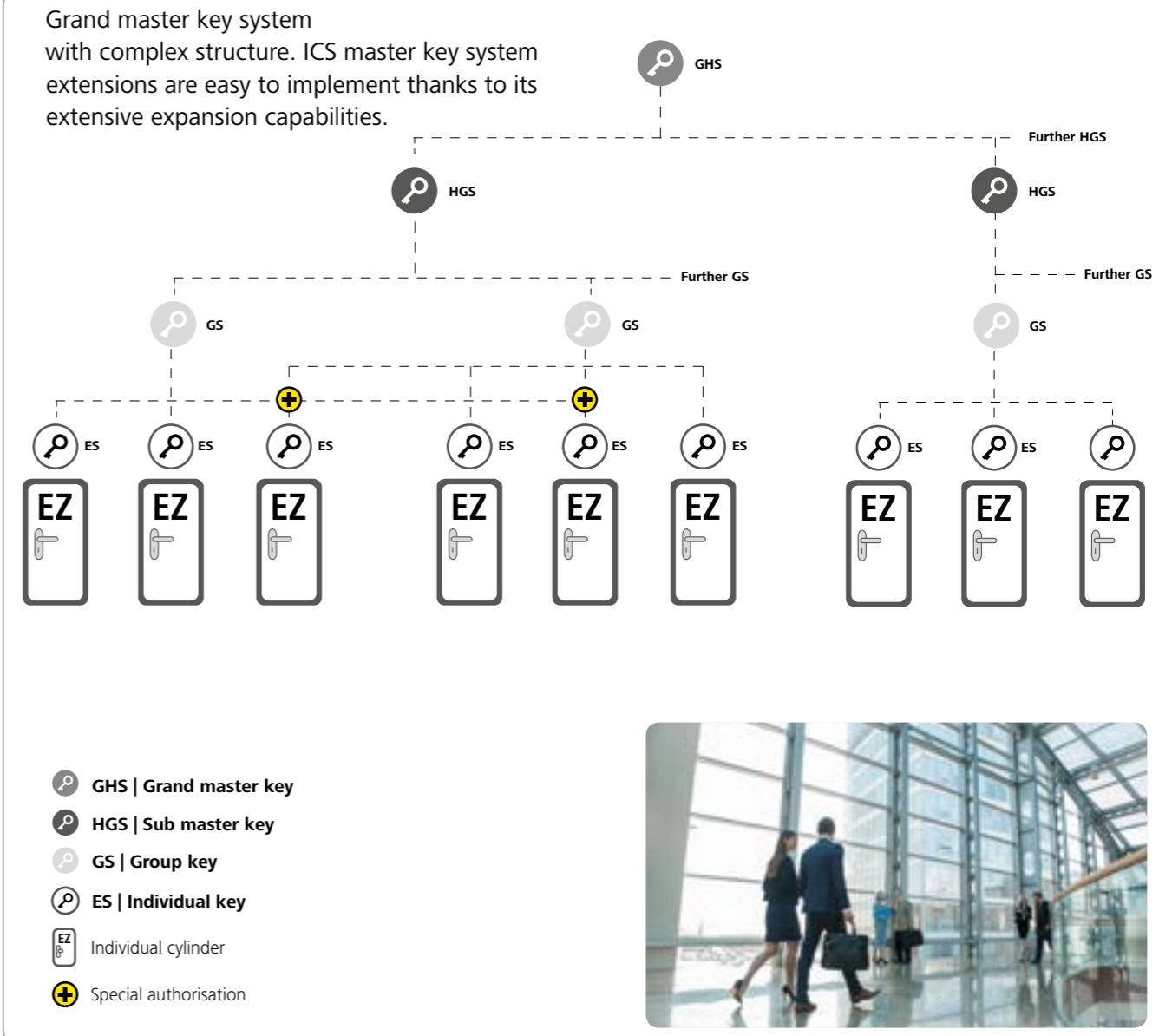

Unique EVVA service

Since 1919, EVVA services have been geared towards customer benefits. This has resulted in products adapted to the market, the best product and consulting service for customers and partners as well as a locking system expertise that boosts customer convenience and gives operators a competitive, economic edge.



Master key systems from professionals

Master key systems define who has access to which facilities. EVVA provides comprehensive expertise in planning master key systems and electronic access control systems. The company's range also includes the calculation of high-performance locking systems with complex authorisation structures.



Your EVVA Partner portal

Our Partner portal provides everything you as EVVA Partners need as part of your everyday activities: price lists, catalogues, data sheets and the option to sign up to training sessions.



Mechanical and electronic systems

EVVA is one of the leading manufacturers that develops and produces electronic and mechanical locking systems in Vienna. EVVA's electronic and mechanical products can be combined in locking systems around the world depending on customer demands.



Excellent advice

EVVA is your reliable partner. Be it for technical queries concerning EVVA products or planning issues regarding a project, you can always count on EVVA.

Innovation made in Austria

Trust a family-owned business that has been researching, developing and producing for 100 years and operates in a respectful and cooperative way. EVVA – Leading European manufacturer in mechanical and electronic locking systems!

www.evva.com

┌

┐

┌ Handed over by

┐