



# EPS

Best pin system





## EPS. Best pin system

EPS reliably protects private houses and is also very popular in clearly structured master key systems in office buildings, catering facilities or residential developments. EPS is the successful result of the continuous further development of tried and tested EVVA pin systems. High level of user comfort and durability make the system the best of pin systems.

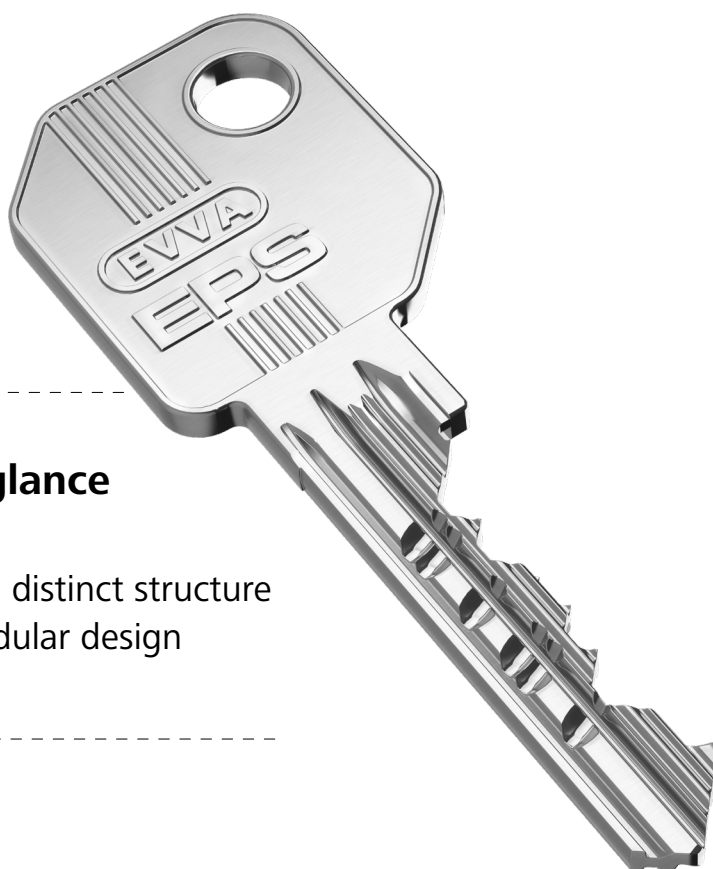

---

### The benefits of EPS at a glance

- › One key fits all
  - › For master key systems with a distinct structure
  - › Quick assembly thanks to modular design
- 

### The access system for clearly structured master master key systems

EPS is ideal for small master key systems and a clearly defined user group. For instance on doors within residential complexes or office buildings. In cooperation with qualified partners, EVVA has been providing security technology for a hundred years.

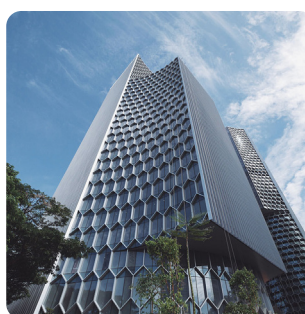

The DUO | SG



Kameha Hotel | DE

# EPS. One system, many details

EPS is a spring-loaded pin system with five or six active, spring-loaded scanning elements and offers up to 20 additional side coding variants. The keys' integrated tampering control within the cylinder and the dual-action locking pins offer a high level of security. The EPS key is a strong nickel silver key with a large key cross-section. EPS cylinders are available in compact and modular design.

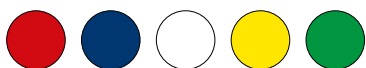
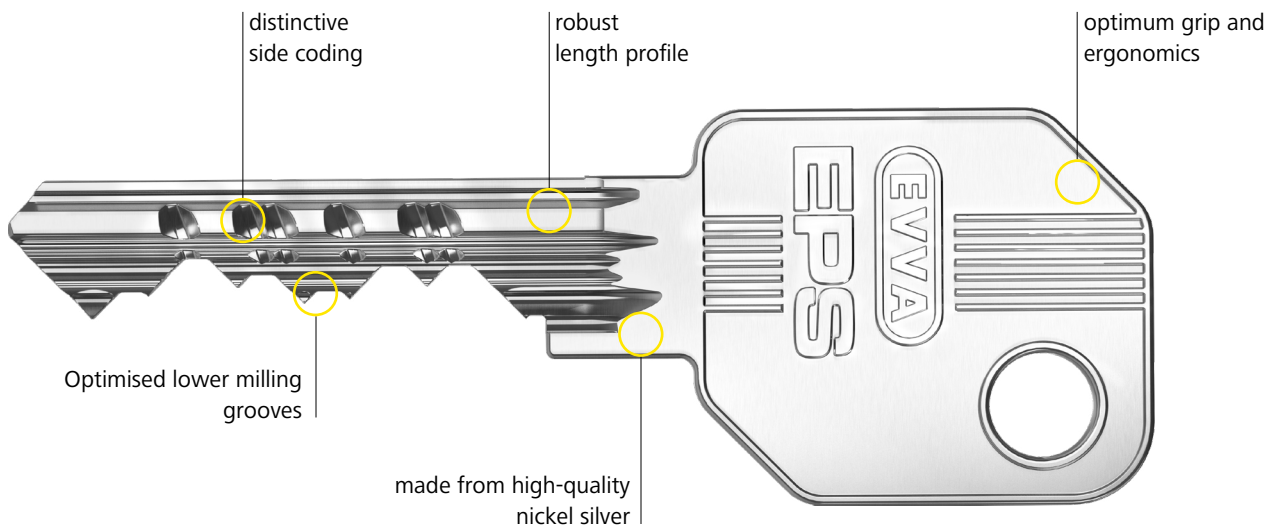

## Practical, handy and appealing.

Optionally, EPS keys are available in a range of colours. The colour coding helps to easily distinguish between keys.



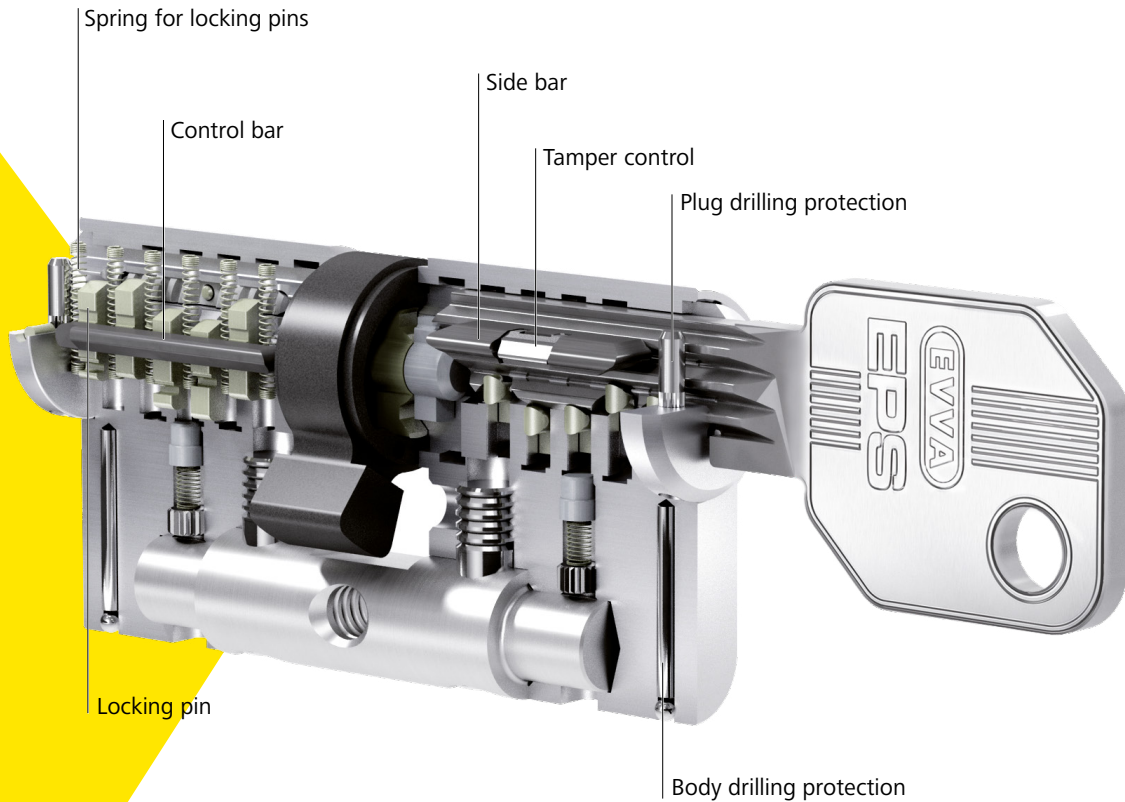

## All-round protection

Copy keys, additional cylinders and lock charts are available from authorised EVVA Partners but only with corresponding proof of legitimacy, the EVVA security card.

## Benefit from the security features

The reliable technology of the EPS cylinder offers lasting protection against illegal opening methods.



Drilling protection



Plug pulling protection





# EPS. Plan view

Due to their features and numerous variants and options, EPS cylinder locks can handle all access situations which a master key system may meet.

Thus, access to rooms and storeys, access to cabinets and showcases or the activation of barriers or other electronic equipment can be clearly structured. This means even more comfort and more security.

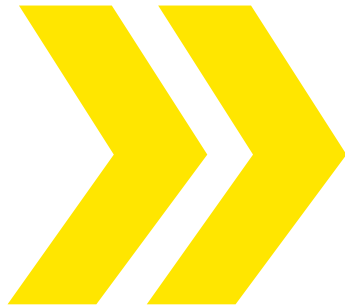

## Furniture cylinder

ensure secure storage of important documents.



## Half cylinder

are suitable for barriers, key switches, lifts and numerous other situations.

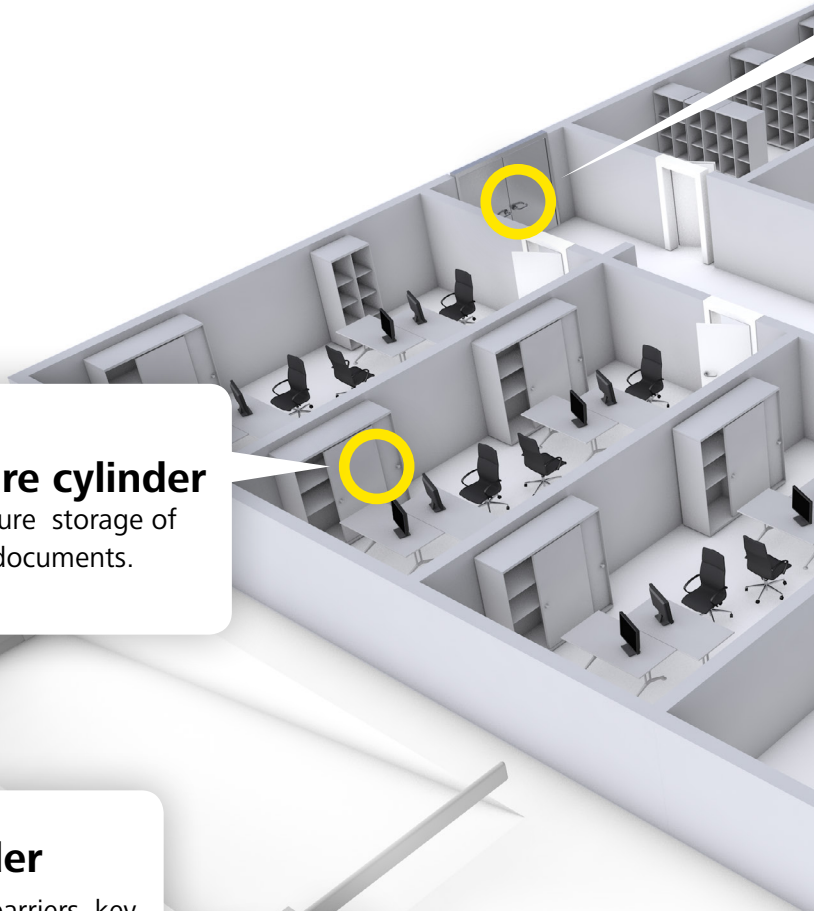

**The right cylinder for every situation**



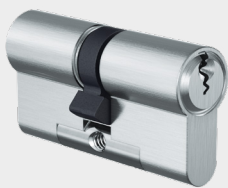

### Double cylinder

are suitable for indoors and outdoors and can be configured with a number of variants and options.

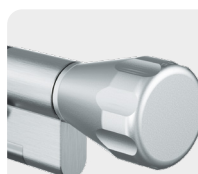

### Thumb turn cylinder

enables convenient opening and closing without keys.



### Switch cylinder

actuate control elements such as those in lift systems.

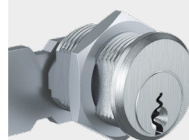

### Cam locks

for letter boxes systems and for secure storage in showcases and cabinets.

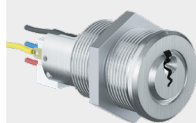

### Switch cylinder with integrated micro-switch

control electronic systems, such as automatic sliding doors.

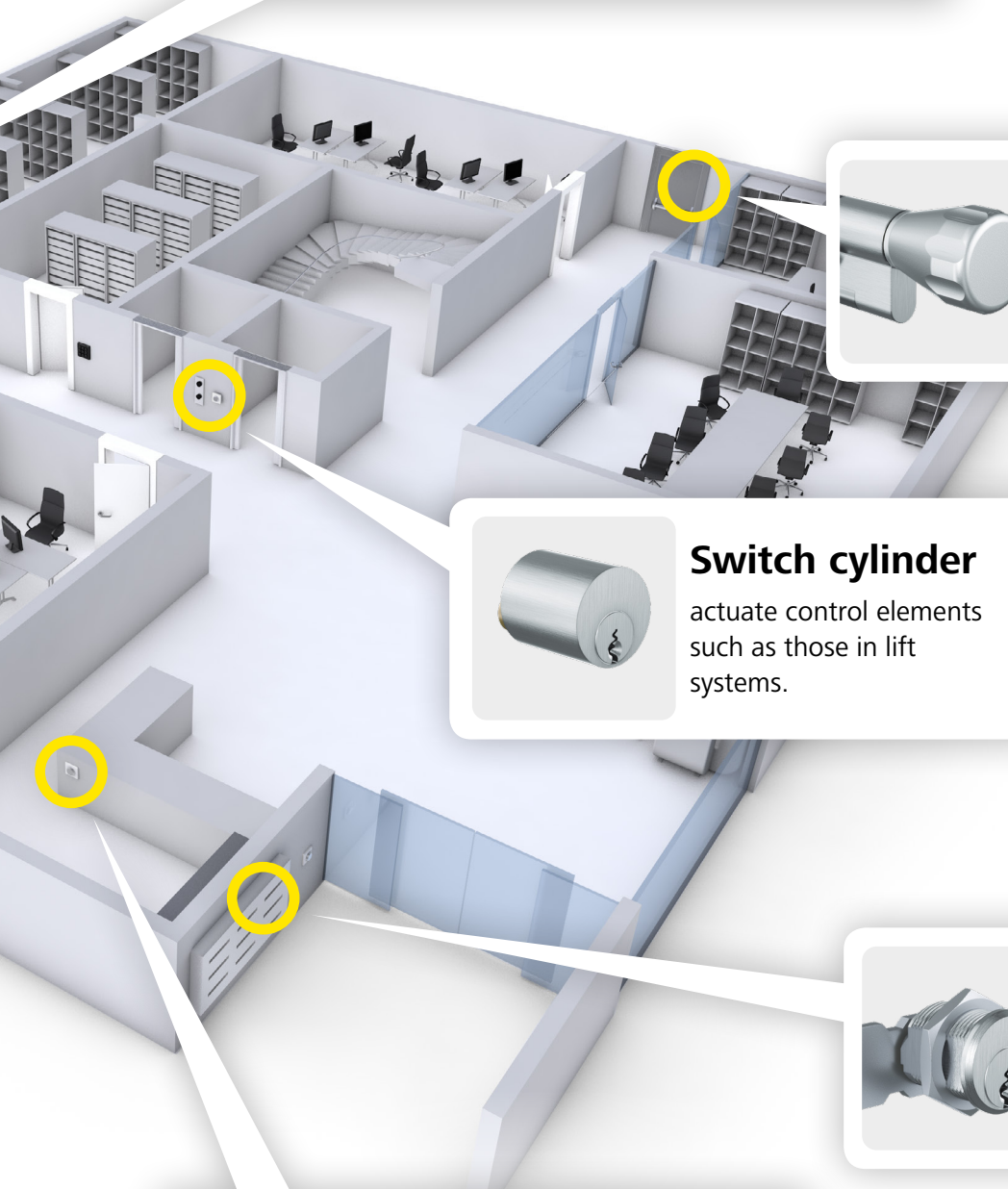

# EPS. Master key systems and structure

EVVA and its project partners have been creating and developing lock charts since almost 100 years, using its extensive know-how to achieve great success.

EPS is the perfect choice for clearly structured master key systems and clearly defined user groups. For example, within residential or office buildings.

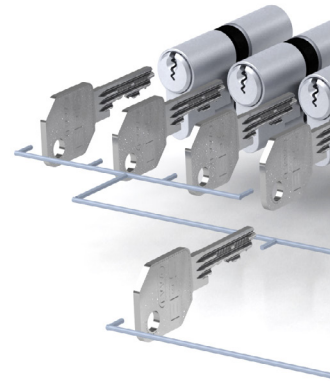

## Example of an residential complex

For apartment cylinders, future master key system extensions are taken into account. If an individual key (ES) is lost, it can be replaced by a new individual key, which again locks all the central cylinders and sub central cylinders.

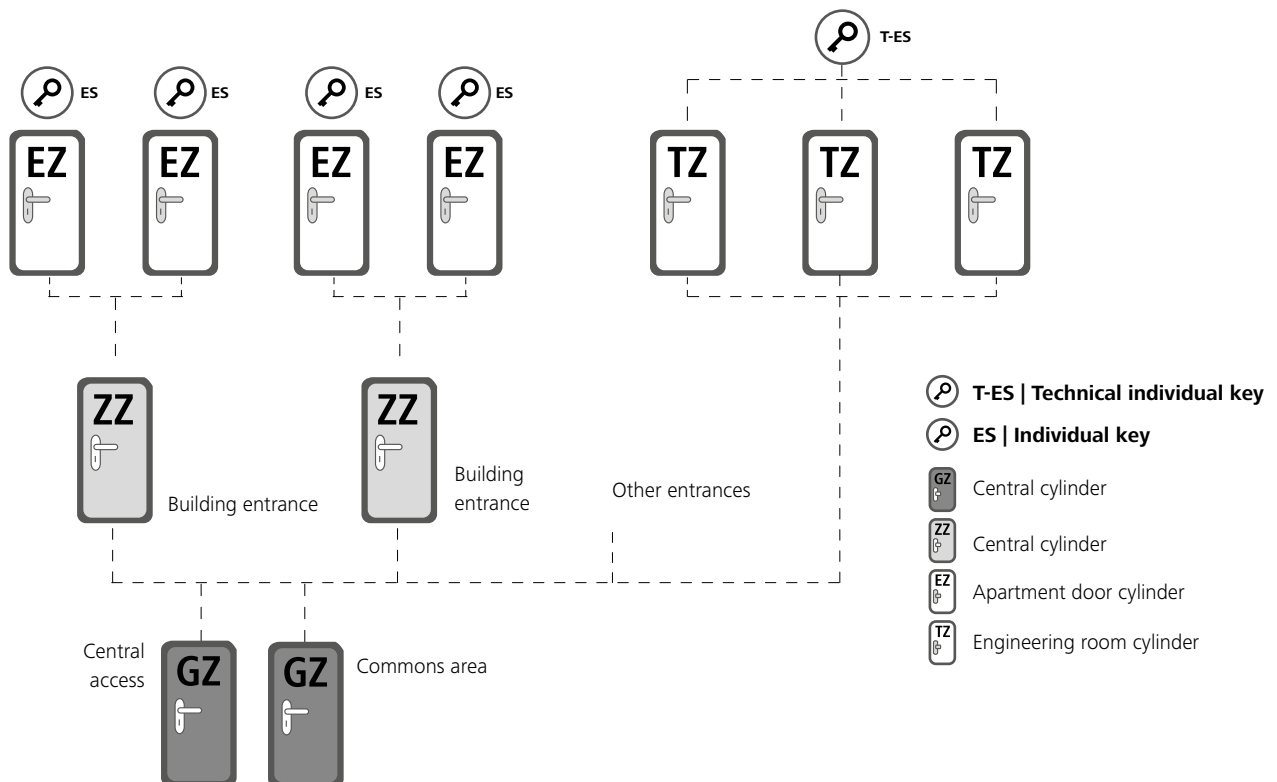



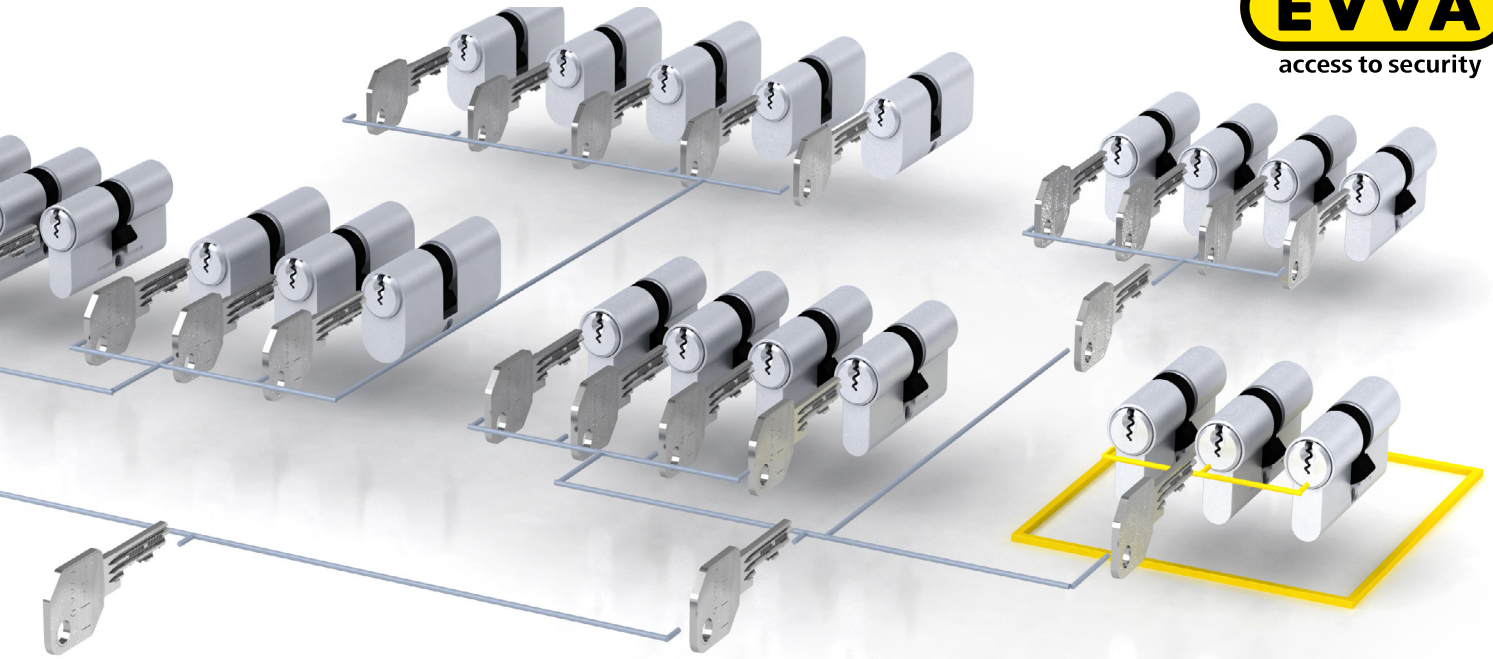



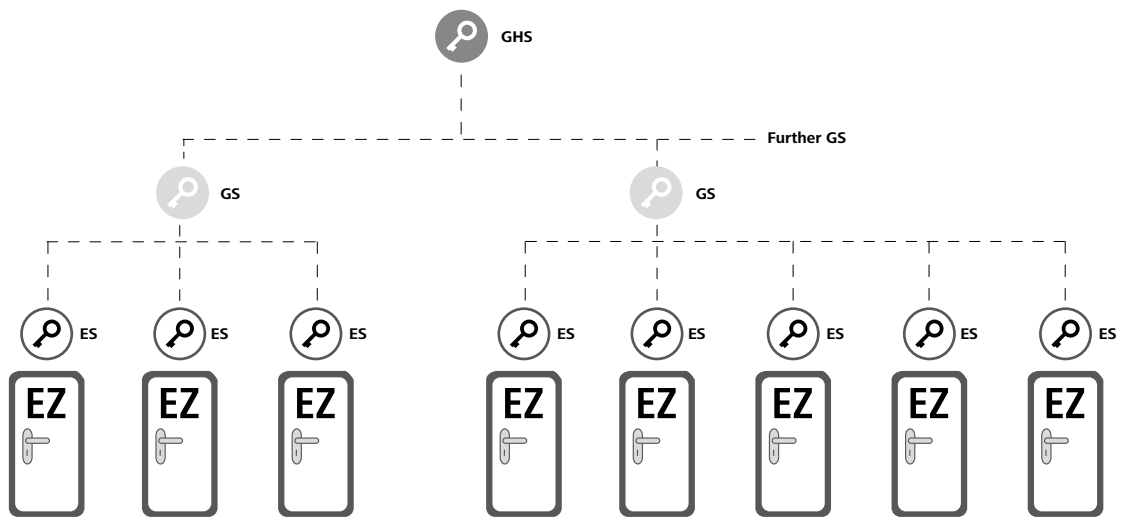

## Example Business premises

In a clearly structured grand master key system, e.g. in a company building employees can only lock their doors, cabinets, etc. while the CEO can lock everything with the GHS key.



-  **GHS | Grand master key**
-  **GS | Group key**
-  **ES | Individual key**
-  **EZ | Individual cylinder**

# Unique EVVA service

Since 1919, EVVA services have been geared towards customer benefits. This has resulted in products adapted to the market, the best product and consulting service for customers and partners as well as a locking system expertise that boosts customer convenience and gives operators a competitive economic edge.



## Master key systems from professionals

Master key systems define who has access to which facilities. EVVA provides comprehensive expertise in planning master key systems and electronic access control systems. The company's range also includes the calculation of high-performance locking systems with complex authorisation structures.



## Your EVVA Partner portal

Our Partner portal provides everything you as EVVA Partners need as part of your everyday activities: price lists, catalogues, data sheets and the option to sign up to training sessions.



## Mechanical and electronic systems

EVVA is one of the leading manufacturers that develops and produces electronic and mechanical locking systems in Vienna. EVVA's electronic and mechanical products can be combined in locking Systems around the world depending on customer demands.



## Excellent advice

EVVA is your reliable partner. Be it for technical queries concerning EVVA products or planning issues regarding a project, you can always count on EVVA.

Innovation made in Austria

Trust a family-owned business that has been researching, developing and producing for 100 years and operates in a respectful and cooperative way. EVVA – Leading European manufacturer in mechanical and electronic locking systems!



[www.evva.com](http://www.evva.com)