



Security Tech Germany

BRAVUS.3000

NO

COMPROMISES

REVERSIBLE KEY SYSTEM

NO COMPROMISES

Bravus.3000



MAXIMUM SECURITY

With its unique combination of maximum technical copy protection, patent protection until 2030* and trademark protection, the Bravus system meets high security requirements. The multidimensional Intellitec verification system on the key and in the cylinder prevents the lock from being operated by unauthorised keys effectively. So Bravus provides reliable protection against illegal key copies and manipulation of the lock cylinder. The security card provides additional protection as this must be presented before additional cylinders and keys can be ordered.

MORE CONVENIENT

The innovative shape of the key makes it almost unnoticeable in a pocket. And the convenient reversible key design makes opening doors as easy in the dark as it is in broad daylight. The modern, solid key never snaps and is made from a high-quality material for long-term security.

AS INDIVIDUAL AS YOUR PROPERTY

From a small property to a massive building complex, ABUS offers custom master key systems based on a sophisticated modular kit. Create your own security solution specific to your building, with options for everything from cylinder types and colours to additional special features. Every cylinder is tailor-made to suit your doors and design concept. And we ensure that your master key system meets your needs in terms of hierarchies and usage conditions. Every user can even have their own individual locking authorisations.

FUTURE- PROOF INVESTMENT

The Bravus master key system can be expanded at any time, giving you maximum flexibility through developments and changes. We can deliver expansion products for your locking system many years after installation.

High-quality raw materials, high-precision manufacturing and our many years of experience mean that you can rest assured in the knowledge that your building is secure. And the fact that the lock cylinders are developed and produced in Germany guarantees premium quality and a long service life.

* max. patent term to 2030

BRAVUS.3000

In detail

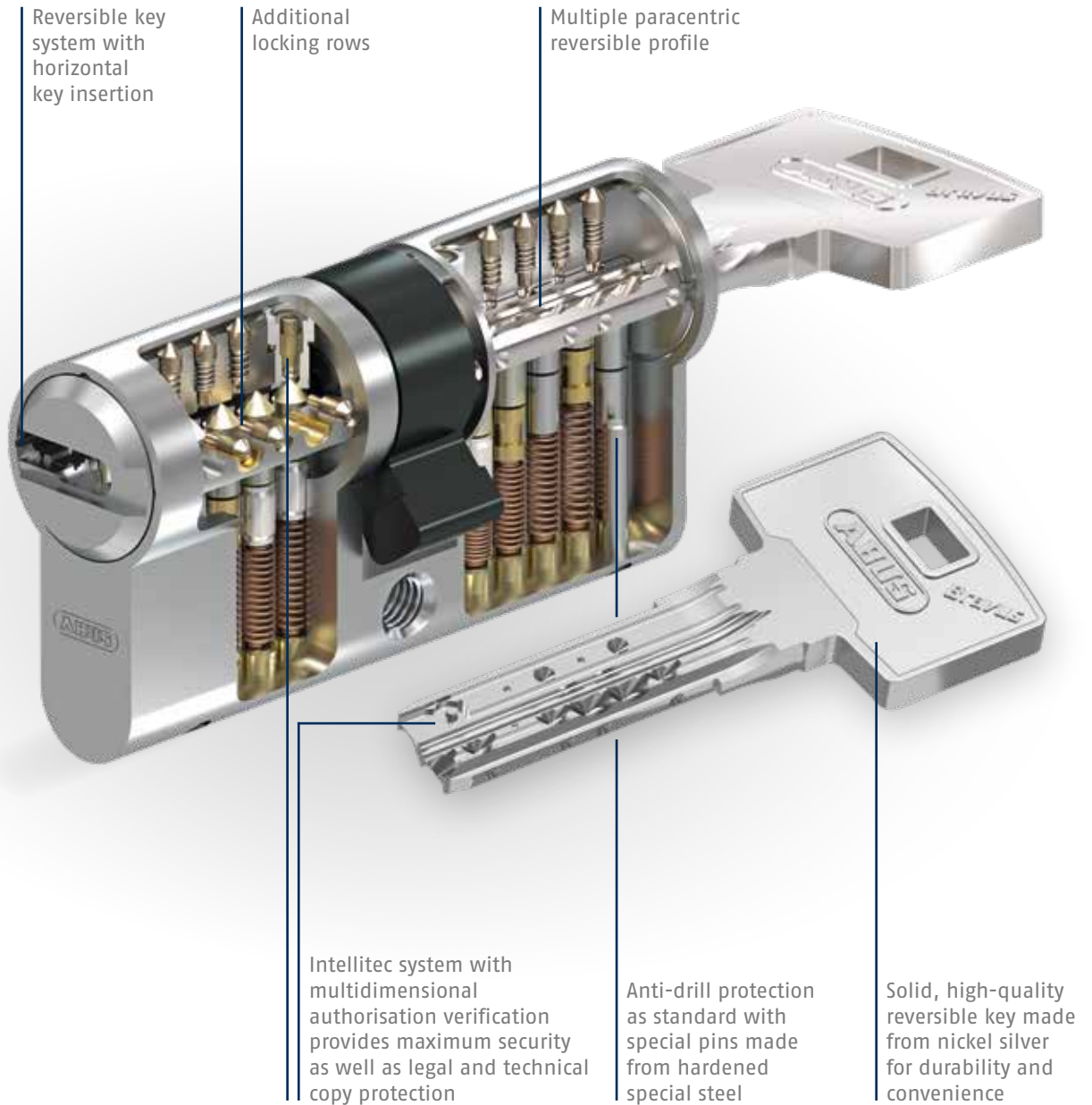



The modern reversible key system with horizontal key insertion is convenient and comfortable to use. The high-quality precision profile ensures easy insertion.



The innovative shape of the key makes it almost unnoticeable in a pocket. The modern, solid key does not snap. It is made from a high-quality material to ensure long-term security.



The Bravus locking system includes the patented Intellitec system* in the cylinder and key. With multidimensional authorisation verification, it offers maximum protection against illegal key copies and manipulation of the cylinder.

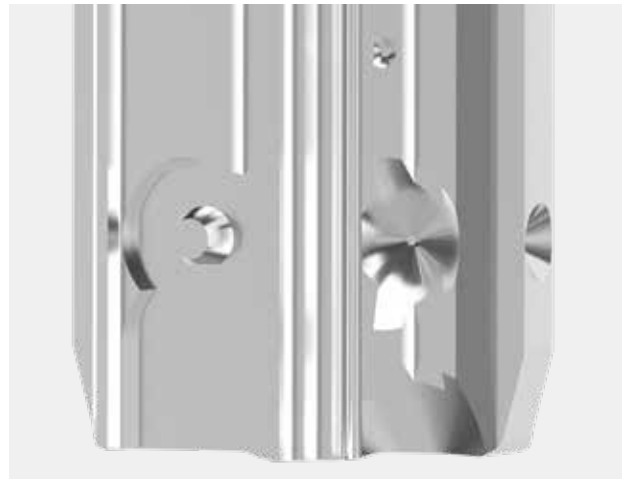

* max. patent term to 2030

SECURITY, HARD AS STEEL

Bravus MX

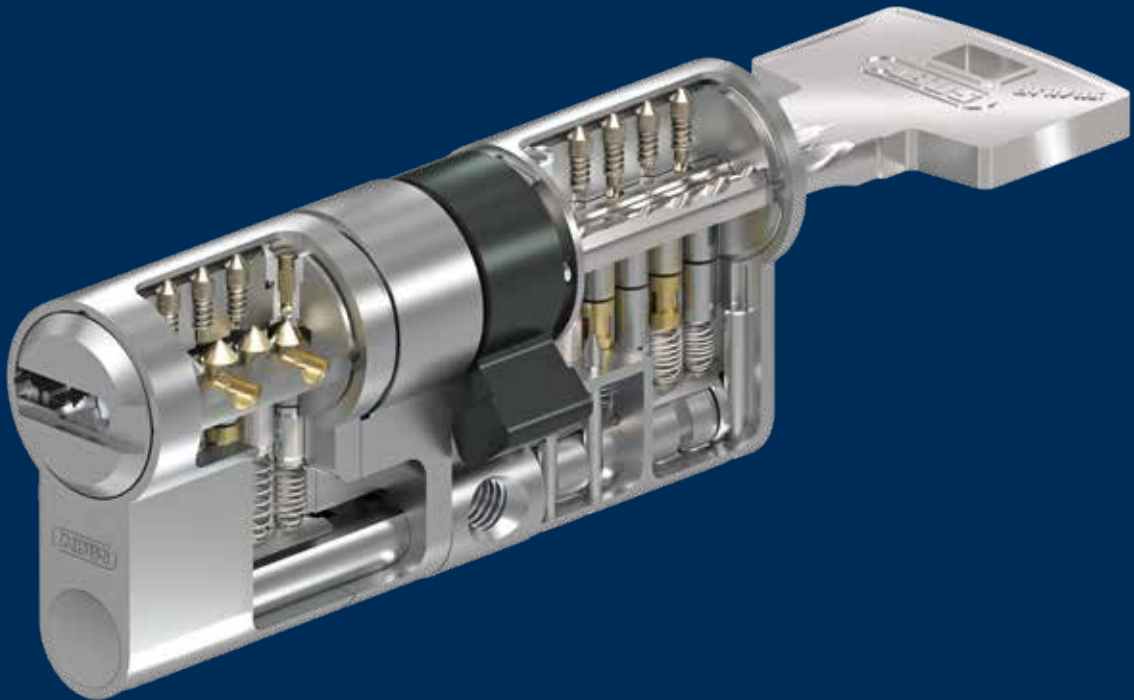

Example image

SECURITY, HARD AS STEEL

The stainless steel elements inside the Bravus MX cylinder provide iron clad security as standard. The stainless steel bar is the key component of the system and provides increased protection against breakage and extraction. The high-strength stainless steel anti-drill inlay and the hardened steel elements inside the cylinder offer increased protection against drilling.

MAXIMUM FLEXIBILITY

Moving?
Installing a new door?
Making changes to your organisational structure?
No problem! Modular cylinders allow you to adapt their lengths to suit your new door. So you can flexibly react to changes.

MIX AND MATCH

For maximum security and flexibility, choose Bravus cylinders with modular MX technology. This allows modular cylinders to be combined with compact cylinders in one master key system, so the Bravus range can meet any requirement you have for your building.



Anti-drill
protection



Anti-shatter
protection



Extraction
protection

TECHNICAL DETAILS

Overview

System:	Bravus.3000
Key:	Multiple paracentric reversible key made from hard-wearing nickel silver, incredibly stable
Key insertion:	Horizontal
Patent protection*:	✓
Trademark protection:	✓
Copy protection:	Intellitec system with multidimensional authorisation verification
Locking rows:	3
Total locking elements:	Up to 16
Modular design:	Optional
Basic length:	30/30 mm and 28/32 mm for Euro profile double cylinders
Length increments:	Extensions available in 5 mm increments
Security card:	✓
Key related security:	Class 6 in accordance with DIN EN 1303, details available on request
Attack resistance:	Class B Class D if special features anti-drill and extraction protection "BZD"
Fire resistance:	Class B, T90
Product certification:	Certified to DIN 18252 and DIN EN 1303 standards Optional, for example SKG*** and VdS, details available on request
Manufacturer certification:	ISO 9001
Production:	Made in Germany

* max. patent term to 2030



ABUS | Pfaffenhain
www.abus.com

Fabrikstraße 1
09387 Jahnsdorf
Germany
+49 37296 713-0
vertrieb@abus-pfaffenhain.de

Technical and colour specifications subject to change without prior notice.
We assume no liability for mistakes and printing errors. © 2018

WRBF_ENB3L
© 08/2018

Specialist dealer

